

SANSUI

NOTHING SOUNDS BETTER

LEDTVSKQ48FH

LEDTVSKQ55FH

OWNER'S MANUAL

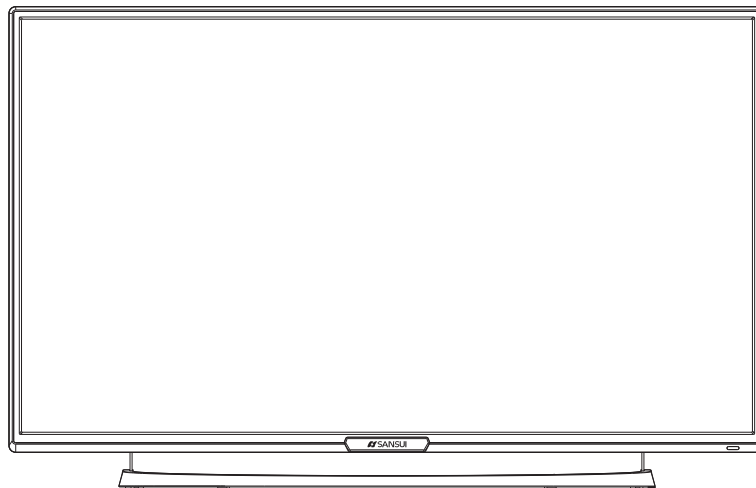

LED TV

Please read this instruction manual carefully before operating your machine. Retain it for future reference.
Record model name & serial number of the machine. Please quote this information when you require service.

Message from the Vice Chairman & CEO

Dear Customer,

It gives me great pleasure to welcome you to the SANSUI family.

Our sincere endeavour is to provide you with best quality products & service support, which lay the foundation for a binding relationship with you. One that stands the test of time to grow stronger with our every interaction.

At SANSUI, we have set ourselves a goal to continuously challenge ourselves to contribute towards your happiness. That's how with extensive research and creativity we present a whole new range of products - designed with superior technology in both picture and sound - so that nothing (else) sounds better.

Warm regards,

(Vice Chairman & CEO)

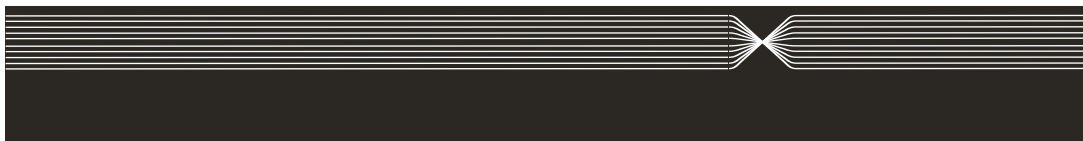

Product Disposal Guidelines



For the purpose of recycling to facilitate effective utilization of resources, please return this product to a nearby authorized collection center, registered dismantler, recycler, service center when disposing of this product.

In case of further assistance, you may contact nearest authorized service center.

Or

Please see the Company website for further information on collection centers etc.
Visit-<http://www.sansui-india.com>

संसाधनों का प्रभावी उपयोग सुगम बनाने हेतु पुनः चक्रण के प्रयोजन से इस उत्पाद को कृपया निकटवर्ती अधिकृत संग्रहण केंद्र, पंजीकृत भंजक या रिसाइकलर (पुनः चक्रणकर्ता) को वापस करें।

अधिक जानकारी के लिए निकटवर्ती अधिकृत सर्विस सेंटर (सेवा केंद्र) से संपर्क करें।

या

संग्रहण केंद्रों इत्यादि के बारे में अधिक जानकारी के लिए कृपया कंपनी की वेबसाइट देखें :-

<http://www.sansui-india.com>

Contents

Safety and warnings.....	2 3
Introduction.....	4
Installation.....	5 9
Remote Controller.....	10
TV Operation.....	11 15
Trouble shooting.....	16

SAFETY AND WARNINGS

IMPORTANT SAFETY INSTRUCTION

- 1) Read these instructions.
- 2) Keep these instructions.
- 3) Heed all warnings.
- 4) Follow all instructions.
- 5) Do not use this apparatus near water.
- 6) Clean only with dry cloth.
- 7) Do not block any ventilation openings, install in accordance with the instructions.
- 8) Do not install near any heat sources such as radiations, heat registers, stoves, or other apparatus (including amplifiers) that produce heat.
- 9) Do not defeat the safety purpose of the polarized plug. If the provided plug does not fit into your outlet, consult an electrician for replacement of the obsolete outlet.
- 10) Protected the power cord from being walked on or pinched particularly at plugs, convenience receptacles, and the point where they exit from the apparatus.
- 11) Only use attachments/accessories specified by the manufacturer.
- 12) Unplug this apparatus during lightning storms or when unused for long periods of time.
- 13) Refer all servicing to qualified service personnel. Servicing is required when the apparatus has been damaged in any way, such as power supply cord or plug is damaged, liquid has been spilled or objects have fallen into the apparatus, the apparatus has been exposed to rain or moisture, does not operate normally, or has been dropped.
- 14) Mains plug is used as the disconnect device, the disconnect device shall remain readily operable.
- 15) The ventilation should not be impeded by covering the ventilation openings with items, such as newspapers, table cloth, curtains, etc.
- 16) No naked flame sources, such as lighted candles, should be placed on the apparatus.
- 17) Attention should be drawn to the environmental aspects of battery disposal.
- 18) The use of apparatus in moderate climate.
- 19) The apparatus shall not be exposed to dripping or splashing and that no objects filled with liquids, such as vases, shall be placed on the apparatus.

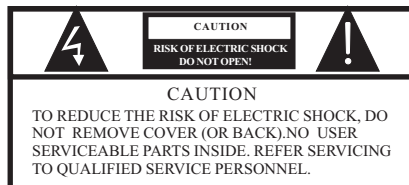

The symbol indicates that dangerous voltages constituting a risk of electric shock are present within this unit.



The symbol indicates that there are important operating and maintenance instructions in the literature accompanying this unit.

WARNING:

To reduce the risk of fire or electric shock, do not expose this apparatus to rain or moisture.

WARNING:

The batteries shall not be exposed to excessive heat such as sunshine, fire or the like.



This symbol indicates that this product incorporates double insulation between hazardous mains voltage and user accessible parts. When servicing use only identical replacement parts.



This marking indicates that this product should not be disposed with other household wastes throughout the EU. To prevent possible harm to the environment or human health from uncontrolled waste disposal, recycle it responsibly to promote the sustainable reuse of material resources. To return your used device, please use the return and collection systems or contact the retailer where the product was purchased. They can take this product for environmental safe recycling.

SAFETY AND WARNINGS

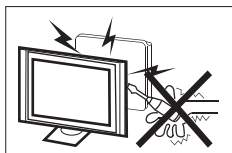

High voltages are used in the operation of this television receiver. Do not remove the cabinet back from your set. Refer servicing to qualified service personnel.

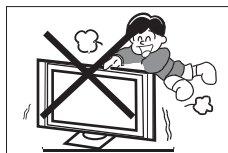

Never stand on, lean on, or suddenly push the television or its stand. You should pay special attention to children. Serious injury may result if it falls.

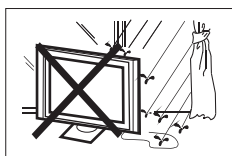

To prevent fire or electrical shock hazard, do not expose the television receiver to rain or moisture.

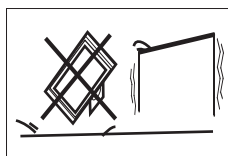

Do not place your television on an unstable cart, stand, shelf or table. Serious injury to an individual, and damage to the television, may result if it falls.

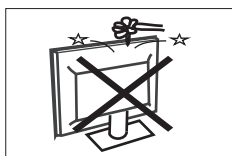

Do not drop or push objects into the television cabinet slots or openings. Never spill any kind of liquid on the television receiver.

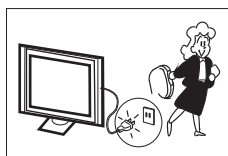

When the television receiver is not used for an extended period of time, it is advisable to disconnect the AC power cord from the AC outlet.

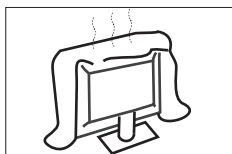

Do not block the ventilation holes in the back cover. Adequate ventilation is essential to prevent failure of electrical components.

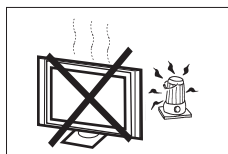

Avoid exposing the television receiver to direct sunlight and other sources of heat. Do not stand the television receiver directly on other products which give off heat, e.g. video cassette players and audio amplifiers. Do not place naked flame sources, such as lighted candles on the television.



Do not trap the power supply cord under the television receiver.

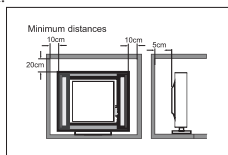

If the television is to be built into a compartment or similar enclosure, the minimum distances must be maintained. Heat build-up can reduce the service life of your television, and can also be dangerous.

Main features

- ① Used as Television, display terminal, PC display;
- ② High luminance, wide viewing angle;
- ③ Can store 200 TV programs;
- ④ HDMI interface;
- ⑤ Multi-Media player (USB);

Accessories

- Infrared Remote Controller..... 1
- Battery(AAA).....2
- User's Manual.....1

SPECIFICATIONS

Viewing Picture Size (Diagonal)	LEDTVSKQ48FH	LEDTVSKQ55FH
Resolution	1920 x 1080	
Aspect Ratio	16 : 9	
TV System	PAL/BG	
Video Signal System	PAL/NTSC/SECAM	
Receiving Channel	1 TO 200	
Input Power Voltage	AC 110-240V 50/60Hz	
Power consumption	80W	120W
Audio Output Power (THD≤7%)	2x10W	

Installation of Standbase Assembly

! Prepare to place the TV with the display side down on a flat surface. Ensure the table or desk you use provides a flat, totally clean surface, and use a soft cloth between the face of the TV and the table to protect the TV's screen.

1. Locate the bottom bracket into the gap in the bottom of the TV, and check that it is securely held in place by its screws.
2. Flat base, the base will be one of the pillars placed in the end seat, make sure the screw holes on the base and the base of the pillars aligned. Let screws into the base of the hole and tighten the screw. In the same way to install another base pillars.
3. Install the screw holes on the back of the base and the base pillars aligned television reserved.
4. Let the four screws into the screw holes and tighten the back of the TV.

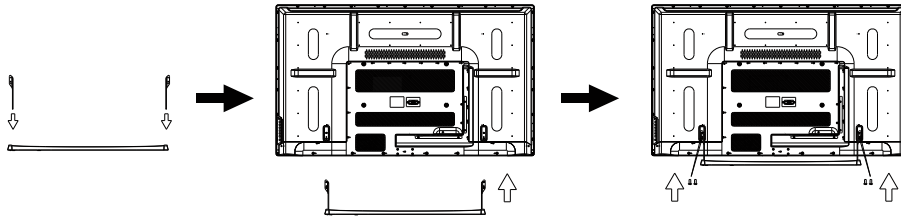

Installation of WallMount Assembly

For wall mounting with an optional bracket, please read the following instructions in conjunction with the bracket's instructions. Make sure qualified service personnel perform the operation.

This television can be wall mounted as follows:

! 1. Place the LED LCD Television face down onto a solid surface. Please place some soft material over the front of the screen to protect it from any damage. The LCD panel is a fragile component, and must be suitably protected when removing the base stand. Be sure that no hard or sharp objects can come into contact with the screen's surface. Do not exert pressure on the front of the unit at any time, as this may damage the LCD screen.

2. Remove the 4 screws from the lower part of the television, where the base joins to the TV, and take away the stand (put the stand and screws somewhere safe for future use).

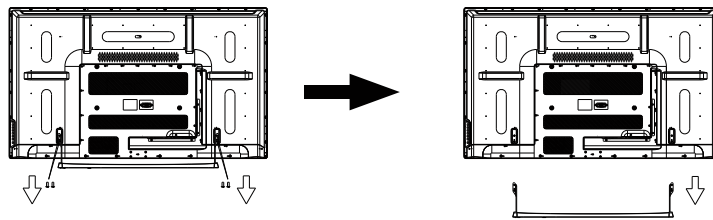

3. Use the M6 screws provided to fix the TV onto a wall mounting bracket (not included) via the VESA standard holes on the back of the television.

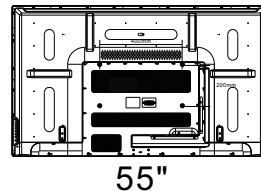
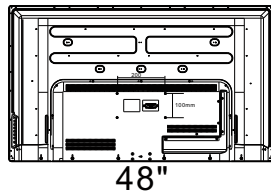

Front panel

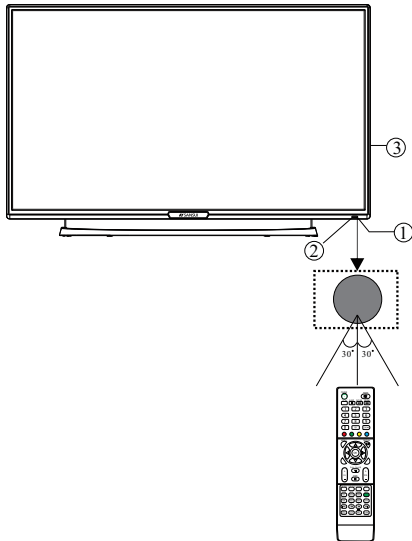

- 1: Remote control sensor.
- 2: Indicator LED: RED ● STANDBY.
- 3: Key board

Key Board Instructions

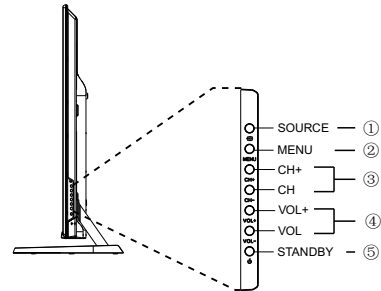

- 1. SOURCE:**
Display the input source menu.
- 2. MENU:**
Display main MENU.
- 3. CH+/CH-**
In TV mode, press “CH+” or “CH-” to change the channel up and down.
In MENU mode, press “CH+” or “CH-” to select items.
- 4. VOL+/VOL-**
Adjust sound level.
In MENU mode, press “VOL+” or “VOL-” to adjust the item that you selected.
- 5. STANDBY**
Press this button to turn the unit ON from STANDBY mode.
Press it again to turn the set back to STANDBY.

Rear AV Connectivities



All the terminals are(from left to right):
AC POWER SOCKET, VIDEO, AUDIO INPUTS, YPbPr.

Note: VIDEO and YPbPr share one audio channel.

Rear AV side Connectivities



All the terminals are (from left to right):
HDMI2, HDMI1, USB, AV OUTPUT, PC AUDIO, VGA, RF.

Note: When HDMI port get DVI signal, the audio signal receives from the PC Audio channel.

ANTENNA

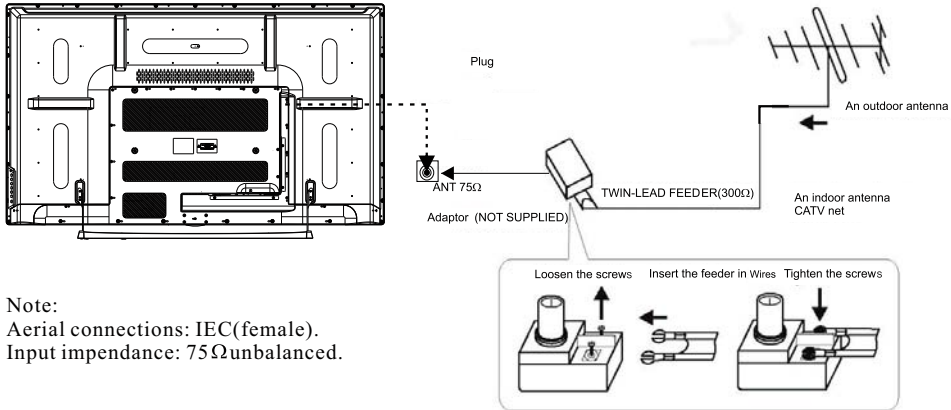

Note:
 Aerial connections: IEC(female).
 Input impedance: 75Ω unbalanced.

PC Connectivity

STEPS:

Be sure both the TV and computer are set to Power off.

1. Connect VGA and audio cable.
2. Connect the power cord.
3. Power on the TV, switch to PC mode.
4. Power on the PC.

This sequence is very important.

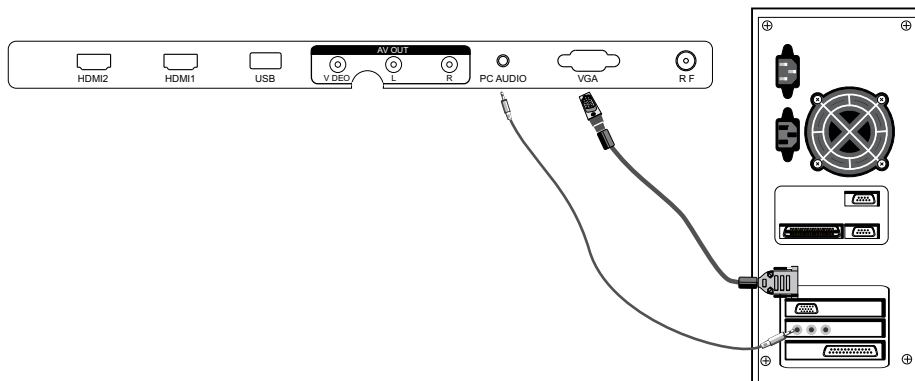

INSTALLATION

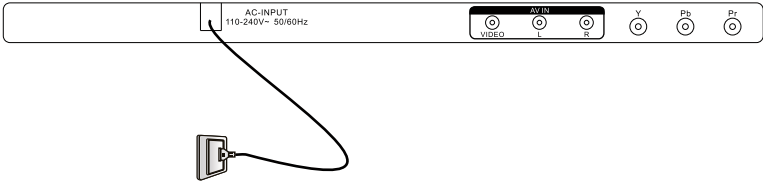

PRESET MODE (PC)

	RESOLUTION	V.Freq.(Hz)	H.Freq.(KHz)
1	800*600	60	37.88
2	1024*768	60	48.36
3	1280*768	60	47.3
4	1920*1080	60	67.5

NOTE: PC V.Freq.(Hz) not more than 60Hz.

PRESET MODE (HDMI)

	RESOLUTION	V.Freq.(Hz)	H.Freq.(KHz)
1	800*600	60	37.88
2	1024*768	60	48.36
3	1360*768	60	47.7
4	1280*768	60	47.3
5	1920*1080	60	67.5

AV Equipments for

This TV provides one group of AV, one group of YPbPr for convenient connection to VCR, DVD or other video equipment. Please refer to the owner's manual of the equipment to be connected as well.

You can use the input terminals on TV set rear as follows.

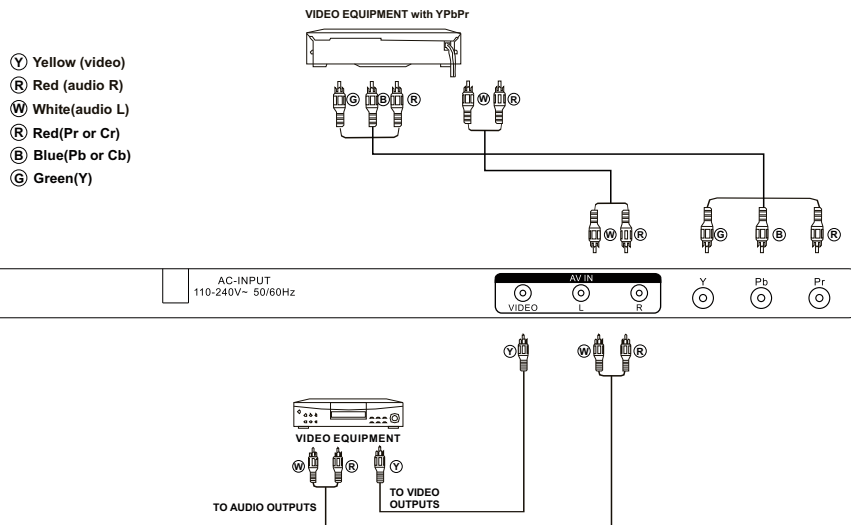
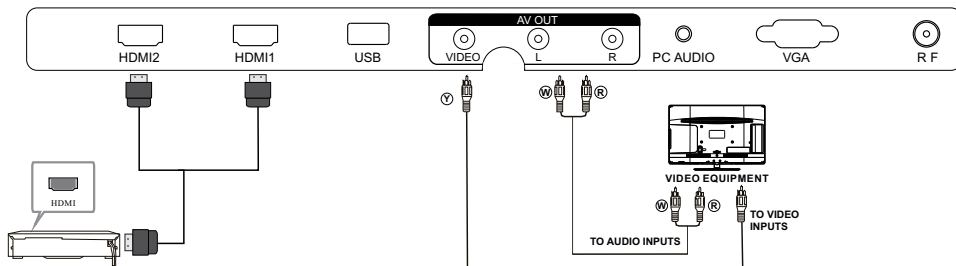

It can be connected to the following appliances: VCR, multi disc player, DVD, camcorder, video game or stereo system, etc.....
 YPbPr can support these video formats:480i,576i,480p,576p,720p,1080i,1080P.

- Note:**
- 1.VIDEO and YPbPr share one audio channel.
 - 2.When HDMI port get DVI signal, the "PC Audio" channel is changed to receive the audio for HDMI port.
 - 3.Sometimes it will not support in different device because the device supplies nonstandard signal.
 - 4.When current source is TV, AV OUT signal is TV; when current source is AV, AV OUT signal is AV; other sources have no AV OUT signal.

REMOTE CONTROLLER

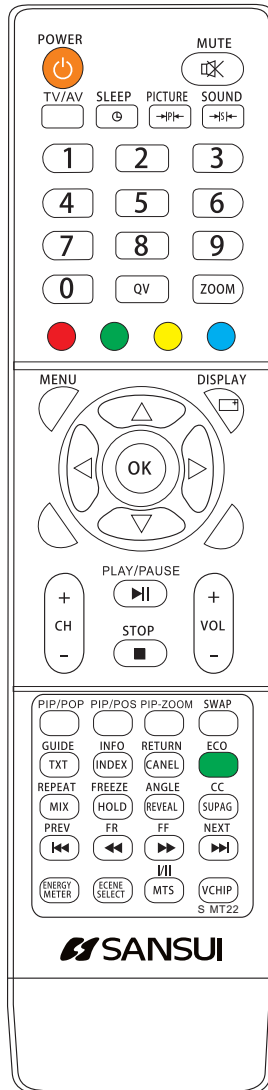

Most of your television's functions are available via the menus that appear on the screen. The remote control supplied with your set can be used to navigate through the menus and to configure all the general settings.

- Turns TV into STANDBY ON/OFF.
- (MUTE)** Reduces the TV's volume to its minimum level. Press again to restore the volume.
- TV/AV** Press to select signal source.
- Sleep** Selects the sleep time.
- Picture** Toggles through the picture preset settings: Standard, Mild, User, Dynamic.
- Sound** Toggles through the sound modes: Standare, Music, Movie, Sports, User.
- 0-9** (numeric buttons) Enters channel numbers.
- QV** Return to the previous channel in TV mode.
- Zoom** Selects the picture size: Auto, 4:3, 16:9, Zoom, Panorama. Under different channels, optional scaling mode is different.
- Red button** Favorite program hotkey.
- Green button** Favorite program hotkey.
- Yellow button** Favorite program hotkey.
- Blue button** Favorite program hotkey.
- Menu** Brings up the menu system.
- Display** Displays the status information.
- ▲▼◀▶** (up, down, left and right direction buttons) Highlights different items in the menu system and adjusts the menu controls.
- OK** Confirms your selection.
- CH +/-** Press CH+ or CH- to go to the next or previous channel.
- VOL +/-** Increases or decreases the TV's volume.
- PLAY/PAUSE** In USB mode, used as Play/Pause key.
- STOP** In USB mode, used as Stop key.
- ECO** Toggles through the BackLight preset settings: OFF, Audio Only, High, Mid, Low.
- PREV** In USB mode, used as Previous key.
- FR** In USB mode, used as reverse key.
- FF** In USB mode, used as forward key.
- REPEAT** Under USB channel, switch to play mode.
- NEXT** In USB mode, used as Next key.
- RETURN** Use this key to return to main multimedia menu while playing a track/item.
- GUIDE** When playing the multimedia file, press [GUIDE] key. The task bar will show for guiding the Multimedia. Under HDMI channel, when "HDMI CEC" function set as "open", used as "ROOT MENU" key.

Following keys are disabled in this model: PIP/POP, PIP/POS, PIP-ZOOM, SWAP, FREEZE, ANGLE, CC, CC, ENERGY METER, ECENE SELECT, MTS, VCHIP

Under HDMI channel, when "HDMI CEC" function set as "open", PLAY/PAUSE, STOP, PREV, NEXT, FF, FR will play function accordingly.

1. PICTURE MENU

PICTURE	Picture Mode	This function is used to select the preset picture settings. (Standard/Mild/User/Dynamic)
	Contrast Brightness Color Sharpness Tint	These settings are used to adjust the Contrast (0-100), Brightness (0-100), Color (0-100), Sharpness (0-100), and Tint (0-100) values for fine adjustments of the picture. NOTE: Tint is enabled for NTSC channels only.
	Color Temp.	Use this option to select and change color temperature.
	Blue Screen	This function is used to ON/OFF the blue back in no Signal condition.
	Aspect Ratio	Select the picture size:Auto, 4:3, 16:9, Zoom, Panorama. Under different channels, optional scaling mode is different.
	Noise Reduction	The DNR (Off/Low/Middle/High) reduce the noise by applying temporal and spatial noise reduction filters to Video data.
Screen	Auto Adjust	Auto setting allows the PC screen of TV to self adjust. This automatically sets the Horizontal position, Vertical position, Phase and Size.
	Horizontal Pos. Vertical Pos.	If picture is not Ok with auto setting then adjust Horizontal position(0-100) / Vertical position (0-100) manually to adjust the desired picture settings.
	Size, Phase	Adjust the phase (0-100) and size(0-100) to remove or reduce picture noise.

Note : 1) The screen menu will be enabled for PC source only.

2. SOUND MENU

SOUND	Sound Mode	This function is used to select the preset sound modes(User, Standard, Music, Movie,Sports).
	EQ	The Equalizer 120Hz, 500Hz, 1.5KHz, 5KHz, 10KHz, (0-100) can be changed by other user.
	Bass	The bass function is used to vary the bass level from 0 - 100.
	Treble	The treble function is used to vary the treble level from 0 - 100.
	Balance	User can select the left/right speaker intensity by changing balance (-50 - +50).
	Volume	The main speaker volume can be adjusted by varying this volume bar (0-100).
	Auto Volume	This function is used to for automatic adjustment of volume level(On/Off).

3. CHANNEL MENU

CHANNEL	Auto Search	Press right arrow key or OK key to start searching & tuning all the available channels.		
	Manual Tuning	Current CH	Displays the current displayed channel. Press Left/Right navigation keys of remote to change the program no.	
		Store To CH	Displays channel no. to store the correct program. Press Left/Right navigation keys of remote to change the program no.	
		System	Displays the Sound system of the current tuned program.	
		Search	Press Left/Right Navigation keys of remote to search the program. Also the program can be selected by directly entering the Program freq. with remote no. keys.	
		Fine Tune	Select this option for Fine tuning the channel with Left right navigation keys at which either Picture or Sound is not clear even after Auto Searching.	
		Frequency	Displays the frequency of the current Program (channel).	
	Program Edit	<p>User can edit the programs by Delete, Rename, Move, Skip, operation</p> <ol style="list-style-type: none"> 1. To delete, Navigate to a channel to delete, press 1, the channel will be deleted 2. To Rename the channel name press 2 on this option and use Up/Down keys to select letters and Left/Right key to navigate between the characters of program name 3. To Move a channel to other program location, Press digit "3" on remote and navigate to list for location to place this channel. Again press "3" to fix location for this channel. 4. To skip any program, press digit key 4 on that channel, then the channel will be marked in the list. When come out of menu and navigate channels, then the channel will not appear <p>Favorite</p> <p>Favorite channels group can be selected with (Red, Green, Yellow, Blue) keys on remote navigate to a channel to be included in favorite list press a color key, the color box same as key pressed appear in front of channel and the channel is included in list to remove the channel from favorite list press same key again, exit menu and press color key, the favorite OSD appear with selected channels to change favorite channel keep pressing color key, channel will be changed. Four favorite groups can be created with four color keys and same channel can be selected in multiple favorites. (Favorite feature is optional).</p>		

Note : 1) Channel menu will be disabled in other source except TV source & when Parental/Disable Search option in Hotel Mode is ON.

4. SETTING MENU

SETTING	Back Light	The backlight value can be varied (0-10) This function is used to adjust brightness level of panel .
	Ecovision	TV is in Normal state when this is on, to save the power consumed by TV select power saving modes Power Saving Off/Low/Mid/High/Audio only mode. in Audio Only mode only audio is On and Picture is off.
	HDMI CEC	This feature operates only in HDMI source. If a CEC compliant device like Home theater or DVD player is connected to TV in HDMI mode, then the Player controls can be operated through TV Remote.
	OSD Duration	Adjust display time of menu
	Software Update(USB)	This is for LCD TV Software update. (For Service only)
	Reset	Select this option to reset all Feature, Audio, Video parameters to Default value

5. PARENTAL MENU

Parental Control	Parent Lock Switch	Make this switch On to Activate the Parental Control options selected by user . When Switch is Off the Parental Control, its options will not Operate.	
	Set Password	Select this option to change the password (default - 0000, master password is 8202) Enter new password and confirm the same.	
	Channel Lock	Press DIGIT KEY 2 key to Lock/Unlock the channels (1-200).	
	Source Lock	Press OK key to Lock/Unlock the Sources (TV/AV /YPBPR/HDMI1/HDMI2 PC/USB). Select the sources to be locked with left/right key on a remote.	
	Clean All	Select this option to reset all Parental options to default value.	
Hotel Mode Control	Hotel Mode Switch	Make this switch On to Activate the Hotel Mode options selected by user . When Switch is Off the Hotel Mode, its options will not Operate.	
	Set Password	Select this option to change the password (default - 0000, master password is 8202) Enter new password and confirm the same.	
	Key Lock	Select this option On, panel keys will not operate.	
	Disable Search	Making this option On, the search options/TV menu will be disabled for user.	
	Max Volume	The main volume is limited by setting MAX volume (0-100), User cannot increase the main volume greater than MAX volume selected.	
	Power On Set	Power On Source	Select the power on source (TV/AV/YPBPR/HDMI1/HDMI2/PC/USB), after the TV ON, the power on source will be same as specified here
		Power On Channel	Select the power on channel (1-200), after the TV ON, the channel will be same as specified here.
Power On Vol		By setting the power on volume (0-100), this volume will be set after set gets ON.	
Clear All	Select this option to reset all Hotel Mode options to default.		

6. USB FUNCTION

You must enter the Source menu first, then choice the USB and press OK button, the USB menu will appear.

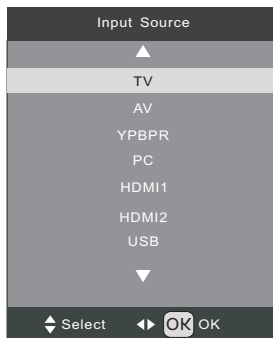

Please make sure that the USB device have plugged in the slot. There are four type media item can be selected, such as photo, music, Movie and text. Select the type media item by pressing ◀▶, press **OK** button to enter the disk selection menu.

In the movie mode, when you use FB, FF function, The audio may be pause in several seconds to synchronize the audio signal and video signal.

In text mode, press ◀▶ to make page up and page down.

NOTE:
When the USB device isn't supported, it may be that the power of the USB device isn't enough.



Press the ◀▶ to select the right disk and press **OK** to display media files and folder list or choose Return to back to the media type selection menu.



Select the media file by pressing ◀▶ or ▼▲, then the preview frame will pop up. Press the button ▶|| to play the media file in full screen. When the media file (photo, music, Movie or text type) is playing, press the **GUIDE** button can display the control bar.

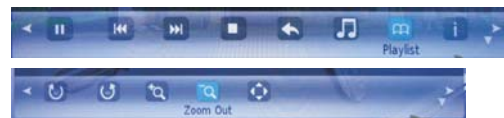

Music function need to put music and picture in the same folder.

Press ◀▶ to select the function icon, press **OK** button to confirm the function.

Press ▼ or **RETURN** button to exit the control bar.

NOTE:
You can adjust the audio track, subtitle, or program in the Info menu while Playing the video file. Choose the Info icon and press **OK** can display the Info MENU.

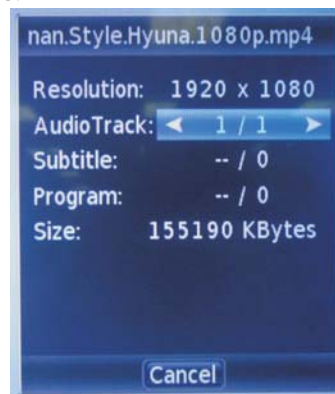













Multimedia (USB) file support

Photo				
Associated parameters File type	Resolution	Compression Option	Support range	
JPEG	15360x8640	Progressive JPEG	Resolution Only Support 1024x768	
		Baseline(Standard)	Support	
		Baseline has been optimized	Support	
BMP	9600x6400	Monochromatism, 16color, 256color, 16bit, 24bit, 32bit	Support	
PNG	9600x6400	Non-interlaced	Support	
		Interlace	Resolution Only Support 1200x800	
Audio				
Associated parameters File type	Sampling rate	Baud rate	Channel	
MP3	32K ~ 48KHz	32K ~ 320Kbps	Mono, Stereo	
WMA	8K ~ 48KHz	32K ~ 320Kbps	Mono, Stereo	
M4A(AAC)	8K ~ 48KHz	32K ~ 320Kbps	Mono, Stereo	
Video(Support.srt Display the .srt. subtitle on the video images)				
Associated parameters File type	File suffixes	Internal encoding	Resolution	Baud rate
MPEG1	.DAT/.MPG/.MPEG	/	1920X1080 @ 30P	Top20Mbps
MPEG2	.MPG	/	1920X1080 @ 30P	Top20Mbps
MPEG4	.AVI/.MP4	XVID	1920X1080 @ 30P	Top20Mbps
RM/RMVB	.RM/.RMVB	RV8,RV9,RV10	1920X1080 @ 30P	Top10Mbps
MKV	.MKV/.MOV	MPEG1,2,4	1920X1080 @ 30P	Top20Mbps
MJPEG	.AVI		640X480 @ 30P	Top10Mbps
Text				
Parameter Files	File suffixes	Character sets	File Size Supported	
Text	.txt	ANSI/UNICODE/GB	Max 3MB	

Resolution Support

YPbPr mode	480i (60Hz), 480p (60Hz), 576i (50Hz), 576p (50Hz), 720p (50Hz, 60Hz), 1080i (50Hz, 60Hz)
HDMI	480i (60Hz), 480p (60Hz), 576i (50Hz), 576p (50Hz), 720p (60Hz), 1080i (50Hz, 60Hz) 1080P (50Hz, 60Hz)

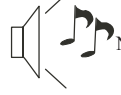
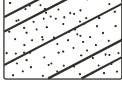
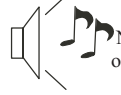
TROUBLE SHOOTING

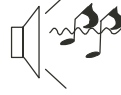
Trouble phenomenon		Inspection
Picture	Audio	
 Snow	 Noise	antenna position, direction or connection
 Ghost	 Normal audio	antenna position, direction or connection
 Interfere	 Noise	electronic equipment, car/ motorcycle, fluorescent light
 Normal Picture	 Mute	Volume (inspect whether the mute function on the remote control are started, or audio system are correct or not)
 No picture	 Mute	Power cord is not inserted Power switch is not opened Contrast and brightness/volume setup Press standby key on the remote control for inspecting
 No color	 Normal audio	color control
 Scramble	 Normal audio or weak	retune channel
 No color	 Noise	Audio system

Special Explanation: The accessories such as remote control is not belongs to the guarantee.

Cut Here 

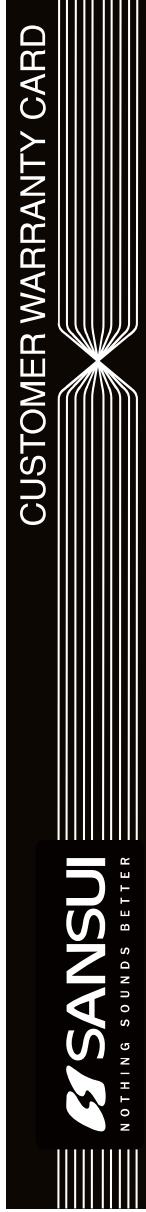

MODEL NO. () ()
SERIAL NO. () ()

NAME OF PURCHASER _____
Last Name First Name Middle Name
ADDRESS _____
CITY _____ STATE _____ PIN CODE _____
PHONE NO. (Residence) _____ (Office) _____
DATE OF PURCHASE _____
CUSTOMER'S SIGNATURE _____



DEALER'S SIGNATURE & STAMP _____

*Refer terms and conditions.

Cut Here 

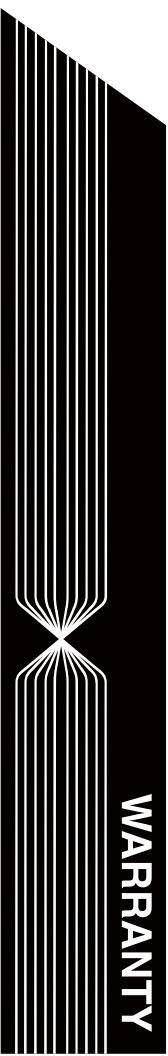
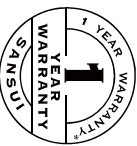

SANSUI CE products come with 1 year warranty, from date of purchase, that comprises of 1 year warranty on all parts. Additional warranty on the product, from the date of purchase of the product, provided always that the warranty card bears the rubber stamp, date and signature of our Authorized Dealer. This card is valid only if it is filled in and stamped by our authorized dealer on the date of purchase.

TERMS & CONDITIONS

1. The warranty is void if the set is not used in accordance with the instructions given in the instruction manual.
2. The warranty does not extend to the set which has been damaged due to misuse, neglect, accident or improper installation. Damages caused by pests or by natural calamities are also not covered by this warranty.
3. This warranty does not cover loss or damage in transit, whether carried by the company's transport or by the purchaser.
4. The company shall not be liable for any delay in rectifying the set, in the event of non-availability of the components and shall in no way be responsible for any losses, direct or indirect, arising out of the delay, if any.
5. The warranty does not hold good, if the set is repaired by any agency non authorised by the company, the serial number of the set is deleted or altered or if any modification is made in the circuitry of the set.
6. The warranty does not extend to accessories, if any, supplied with the set.
7. In the event the set requires attention, the purchaser should arrange to deliver the same to the nearest service centre at his/her own cost.
8. The warranty shall be confined to the first purchaser of the set only.
9. The warranty is issued subject to the jurisdiction of civil courts at Mumbai only.
10. This set is meant for home entertainment purpose. Warranty is not valid if the set is used for commercial purpose.

The warranty card should be completely filled and service station copy dispatched to the nearest service centre within ten days from the date of purchase. Any changes in address should be notified to the service centre immediately.

NOTE:

- sansui will not be responsible for any injury, loss or damage, direct or consequential, arising out the use of, or inability to use this color television set.
- The warranty stands void in case of transfer of ownership of this colour television set.
- In case of replacement of any part the defective part shall owned and possessed by the company.

Cut Here 

SERVICE STATION COPY

MODEL NO. _____ SERIAL NO. _____

NAME OF PURCHASER _____

Last Name First Name Middle Name

ADDRESS _____

CITY _____ STATE _____ PIN CODE _____

PHONE NO. (Residence) _____ (Office) _____

DATE OF PURCHASE _____

CUSTOMER'S SIGNATURE _____

DEALER'S SIGNATURE & STAMP _____



Cut Here 

BUSINESS REPLY CARD

Affix
Stamp
Here

SERVICE CELL, VIL CAMPUS,
15km STONE, AURANGABAD -PAITHAN ROAD,
CHITEGAON, TALUKA PAITHAN,
DISTRICT AURANGABAD - 431 105
PHONE NO. : (02431) - 329271, 329783, 251598
E MAIL : service@tekcaremail.com

BRANCH OFFICES

BRANCH ADDRESS		PHONE NO
NORTH ZONE		
Delhi	71/7, A-2 Block, Rama Road Industrial Area, Moti Nagar, Metro Station New Delhi-110015	011-32511634
Gurgaon	309/310, 4th Floor, Cybiz Centre, Udyog Vihar, Gurgaon-122015.	0124-2863000
Chandigarh	SCO 80-82, 2nd Floor, Sector-17D, Chandigarh-160017	0172-3240131/32/33
Jaipur	701-701, Brij Anukampa Tower, Ashok Marg, C-Scheme, Jaipur	0141-5113785
Karnal	SCO-137, 2nd Floor, Above Rajasthan Bank Main Market, Sector-13 Karnal, Haryana -132001	0184-3293404, 3293395/90
Ludhiana	H.No. 1408, Gobind Nagar, Kaka, Marriage Palace Road, Ludhiana	0161-5078433/5079433
Agra	32/1/13A, Near Jyoti Dham, Water Works Crossing, Bye Pass Road, Agra-282005	0862-3201514/15
Lucknow	75, 2nd Floor, Raja Ram Kumar Plaza, Hazratganj, Lucknow-226001	0522-3242741/3251902.
Dehradun	C-2, Lane No-1, Shastrinagar, Dehradun	0135-3203268
Jodhpur	19B, Heavy Industrial Area, Opp. Jodhpur Dairy, Jodhpur	0291-2613666
Jalandhar	Kothi No.50, Golden Avenue Urban State, Phase-I, Jalandhar	9878894732
Varanasi	D-64/132, KA-3, Siga (behind Handloom House) Varanasi-21010	0542-3254104
Jammu	Plot No. 86, Yard No. 6, Transport Nagar, Narwal, Jammu.	0191-2490070
Ghaziabad	R/8/21 Raj Nagar, Ghaziabad-201001	0120-3230421-25
EAST ZONE		
Kolkata, Siliguri & Asansol	Flat No. A-1, 14th Floor, Chatterjee International Center, 33A, Jawaharlal Nehru Road, Kolkata-71	033-32984928, 5086-32578722 Fax-23673470
Bhubaneswar	2nd Floor, Amapurna Complex, Plot No. 263, Bapuji Nagar, Bhubaneswar	0674-3250137
Ranchi	2nd Floor, A.H. Complex, Opp. SFC, Godown, Kadru, Ranchi-834002	0651-3255086, 3254490
Guwahati	Mandakini, 1st Floor, Besides Pizza Restaurant, Pragati Path, R.C. Baruah Road, Zoo Road Tinali, Guwahati -781005.	9854748944
Patna	1/8 Abhujik Bhawan, North Sk Puri, Patna -800001	0612-3299774
WEST & CENTRAL		
Mumbai	Marol Bhavan, Marol Co-op. Industrial Area, Makwana Road, Marol, Andheri - East, Mumbai -400059	022-40584600, Fax-40584605
Thane	601, B-Wing, 6th Floor, Above Kalra-Nidhi Show Room, Ronak Arcade, Cokhale Road, Navpada, Thane -West-400602	022-23561428, 32403426
Pune	1/1 Lalwani Estate, Maharsini Nagar Corner, Pune Satara Road, Behind Dena Bank, Pune-411037	020-24260329/ 24260489
Indore	1st Floor, 10 Malwa Tower, Old Palasia, A.B.Road, Indore-452018, Madhya Pradesh	0731-3520626/27/28
Ahmedabad	3rd Floor, Videocon House, Opp. Umalaya Hospital, B/H Urja House, Nr. Swastik, Cross Road, Navrangpura, Ahmedabad-380 009.	079-26408976/26400418 Fax No. 079-2656526
Nasik	Madhura Complex, Near Dondre Bridge, Untwadi, Pawan Nagar Road, Cidco, Nasik-9	0253-2391447/3298474/3299486
Aurangabad	Plot No. 511, Jasodhasmriti, N-3, Cidco, Aurangabad-431003	0240-3090240, 2471201,202
Nagpur	92, Temple Road, Civil Lines, Behind Nag Vidarbha Chamber of Comm; Nagpur-440001.	0712-2520993, 2543079,
Goa	Kamat Complex, Building No. 03 1st Floor, Tonca, Panjim, Goa	0832 246245
Bhopal	1st Floor, 221 Bisaria Complex, M.P. Nagar, Zone-I, Bhopal	0755-3295535, 3295537
Jabalpur	1421, 1st Floor, Near Jabalpur Warehouse Wright Town, Jabalpur	0761-3291276, 3291272
Raipur	535/1, Behind B.P. Pujari School, Raja Talab, Raipur-492001	0771-3294294, 3295605
Baroda	1st Floor, Ramkrishna Chambers, BPC Raod, Aikapur, Baroda-390005	0265-2359084/2353552
Rajkot	201, Heera Panna, Dr. Yagnik Road, Rajkot-360001.	0281-2465041, 2460315
Surat	2nd Floor, Gandhi Palace, Near Jain Mandir, Opp. Triveni Apartment, Nanpura, Timali Wadi, Surat-395001.	0261-23471556, 5419, 6636
SOUTH ZONE		
Chennai	Plot No. 1513, New No.15, 1st Floor, J Block, 13th Street, Anna Nagar West, Chennai-40	044-26161896
Bangalore	"2nd Floor, 3rd Cross, 8th Main, Vasanthnagar, Nr. Mount Carmel College, Bangalore -560052	080-32916995/93/91/96, Fax-22383099
Cochin	Gowrishankaram 39/27/30 2nd Floor, Durbar Hall Road, cochin -682016	0484 3230150/51/52
Hyderabad	2nd Floor, Pojoa Edifice, Building, opp-shoppers Stop, Begumpet, Hyderabad-500016	040-32926481-2-3-4, Fax-27767892
Coimbatore	"250-A, Sangapur Main Road, Kannappa Nagar Coimbatore.641027"	042-22333146
Madurai	No. 82, Preetam Plaza, Bye-pass Raod, Madurai 625010	0452-4354422, 3293686.
Vijayawada	D.No.59-14-50, 4th Floor, B.S.R. Plaza, Ring Road, Opp. Maris Stella College, Vijayawada -520 008.	0866-3298004.
Vizag	D.No.30-15-140, Flat No- 101, Tirumala Plaza, Daba Gardens, Visakhapatnam -530 020	0891-3240251.
Hubli	No.27, 2nd Main, 2nd Cross, Kalyan Nagar, Vidyanagar, Hubli -580031.	0836-3291134, 0836-3291139*
Mangalore	Sterling Chambers, #5-5-347/11, Shop No-g3, Ground Floor, Kalakunja Road, Kodialbail, mangalore-575003.	8242491388
Calicut	2nd Floor, 5/2671, a-10, Corner Space Bldg, Cherooty Nagar Housing Colony Jn. Calicut-673 004.	0495-3249997, 3205727, Fax-2771137
Warangal	Flat No.207, 4 Th Floor, 91 Bhuvana Tower, S.D. Road, Secunrabad-500003	040-27810021

For Service, please refer to the back page.



SANSUI

NOTHING SOUNDS BETTER

24X7 SERVICE & AMC

Landline-Toll Free

39 40 40 40

Prefix the STD code of the state capital
SMS - 'SVC' to 53030

Customer First



Marketed by - **KAIL LIMITED**,
Auto Cars Compound, Adalat Road, Aurangabad,
Maharashtra, 431005, INDIA.